

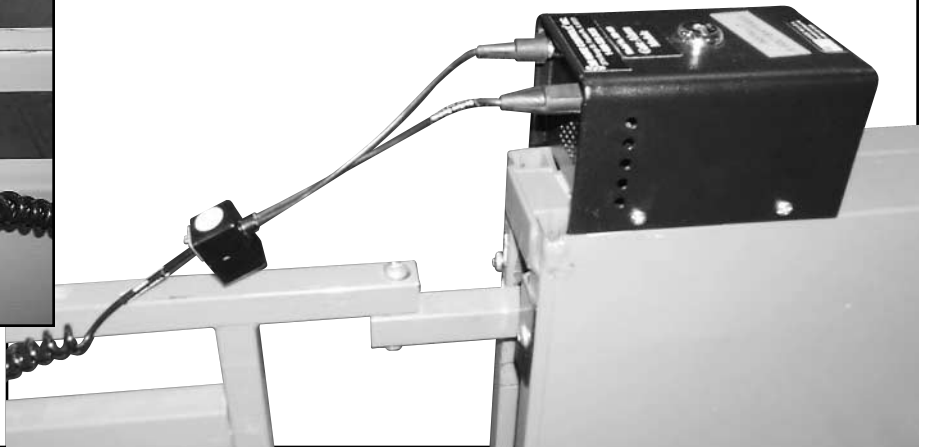

Installation Instructions for the

HD-403 Gate Alarm

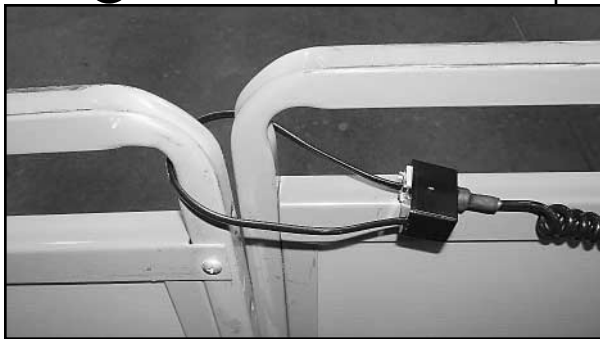

HD-403
Gate Alarm Alarm Module



HD-405
Gate Alarm RCA Connector



HD-407
6' Coiled Gate Alarm Collar Lasso Sensor

Battery Installation:

Step 1. Removing the Alarm Cover
As shown in Fig. 1 at right, remove the (4) screws around the base of the Alarm Module. Place the key in the lock, turn it (clockwise) to the "Stand-By" position as shown in Fig. 2. You can now remove the cover.

Step 2. Install the Batteries: position (2) two 9 volt alkaline batteries, (not included) above the circuit board, pushing them onto the battery connectors. Make sure the (+) positive and (-) negative line up properly as shown in Figs. 3 & 4.

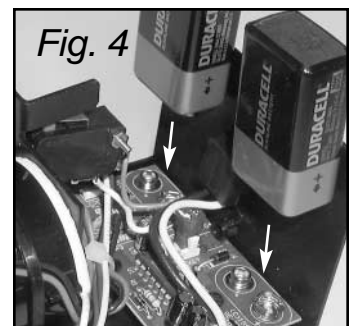
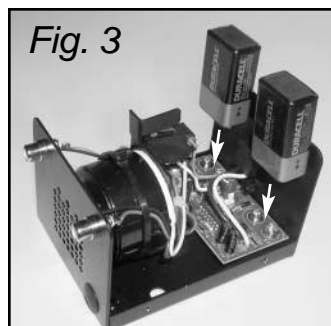
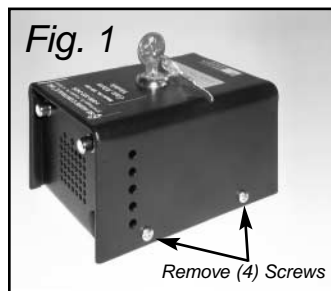

Rev.7/14/05 ©2005 Se-Kure Controls® Inc. SCI-9801



Se-Kure Controls®, Inc.

On the Web: www.se-kure.com
E-Mail: info@se-kure.com

3714 Runge Street • Franklin Park, IL 60131-1112 • (847) 288-1111 • 1-(800) 322-2435 • Fax: (847) 288-9999



Installation Instructions for the

HD-403 Gate Alarm

Mounting the Gate Alarm:

The HD-403 Gate Alarm can be mounted with either screws or double sided tape. Please Note: mounting hardware is not supplied in the kit.

Step 3a. As shown in Fig. 5 and 6, the Alarm Module has two screw holes in the base so the unit can be screw mounted to a flat surface.

Step 3b. As shown in Fig. 7, the Alarm Module can be mounted with double sided tape.

Step 4. Replace the cover onto the Alarm Module, (leave the key in the Alarm Module in the "Stand-By" position); re-install the (4) screws around the base of the unit. See Fig. 8.

Step 5. Plug the HD-405 Gate Alarm RCA Connector into the Alarm Module as shown in Fig. 9. The RCA plugs on the connector can plug into either socket as long as both RCA connectors are connected to the Alarm Module. See Fig. 10.

Step 6. Plug the HD-407 Collar Lasso Sensor onto the end of the RCA Connector.

Step 7. Unplug the looped end of the Collar Lasso, wrap the cable around to "Lasso" the two gates together, and replug the lasso end of the sensor as shown in Fig. 11.

Turn On & Re-Arm The Alarm Module:

Step 8. Turn the key to the "On" position and remove the key.

After the alarm has been set off, you can re-arm the module by re-inserting the RCA cable, (the unit will re-arm itself after 30 seconds). Or, by inserting the key and turning (clockwise); re-insert the cable back into the Alarm Module, and turn the key (counter clockwise) and remove.

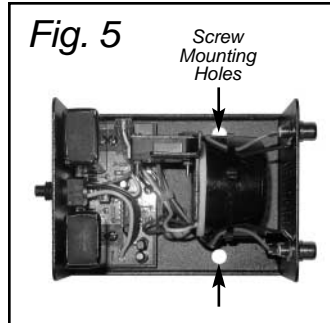

Fig. 5

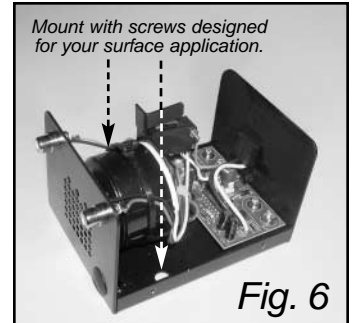

Fig. 6

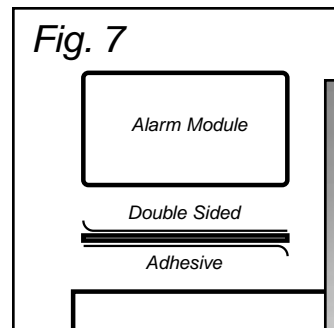

Fig. 7



Fig. 8

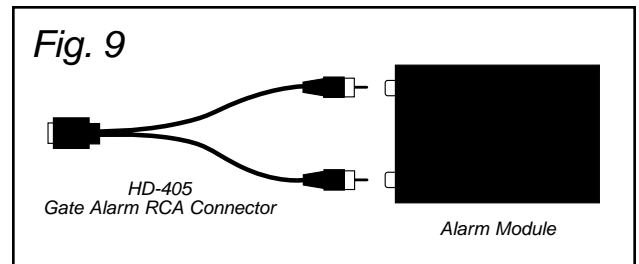

Fig. 9



Fig. 10

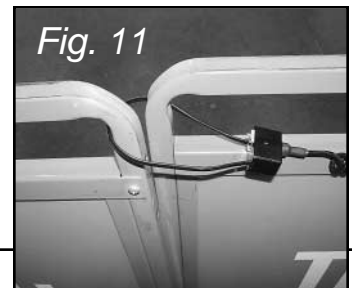

Fig. 11

Rev.7/14/05 ©2005 Se-Kure Controls® Inc. SCI-9801



Se-Kure Controls®, Inc.

On the Web: www.se-kure.com
E-Mail: info@se-kure.com

3714 Runge Street • Franklin Park, IL 60131-1112 • (847) 288-1111 • 1-(800) 322-2435 • Fax: (847) 288-9999